

CRANE

CRYOFLO_{H₂}

Keeping Cryogenics Cool

LIQUID HYDROGEN
BELLOWS SEAL GLOBE
& LIFT-CHECK

VALVE

www.cranecryoflo.com

brands you trust.

REDUCED HEAT FLUX. INCREASED FLOW RATE.

CRANE CRYOFLO® Bellows Seal Globe and Lift-Check Valves stop Hydrogen loss by minimizing heat transfer rates, reducing pipeline latency in liquid transfer applications and leveraging bellows zero-leak design.

CRANE ChemPharma & Energy



Table Of **CONTENTS**

04-07	About Crane ChemPharma & Energy
08-09	About Crane CRYOFLO®
10	Productline Overview
11-20	Bellows Seal T & Y Globe Valve
12-14	Product Details
15	End Connections
16-17	T & Y Globe Features
18	In-Line Repair
19	Testing
21-26	Lift Check
22-24	Lift Check Key Features
25	Product Applications
27	How to Order
28	Index: Unit conversion



Crane ChemPharma & Energy **INTRODUCTION**

Crane Co. is a diversified manufacturer of highly engineered industrial products with a substantial presence in a number of focused niche markets. We are dedicated to integrity and honest dealings in all that we do.

Crane CP&E designs and manufactures a variety of high performance products including: highly-engineered check valves, sleeved plug valves, lined valves, process ball valves, high performance butterfly valves, bellows sealed globe valves, aseptic and industrial diaphragm valves, multi/quarter-turn valves, actuation, sight glasses, lined pipe, fitting and hoses, and air-operated diaphragm and peristaltic pumps. Its trusted brands are in use worldwide in many industries, including Oil & Gas, Oil Refining, Petrochemical, Power Generation, Chemical Processing, Biotechnology, and Pharmaceutical.

Crane CP&E WORLDWIDE

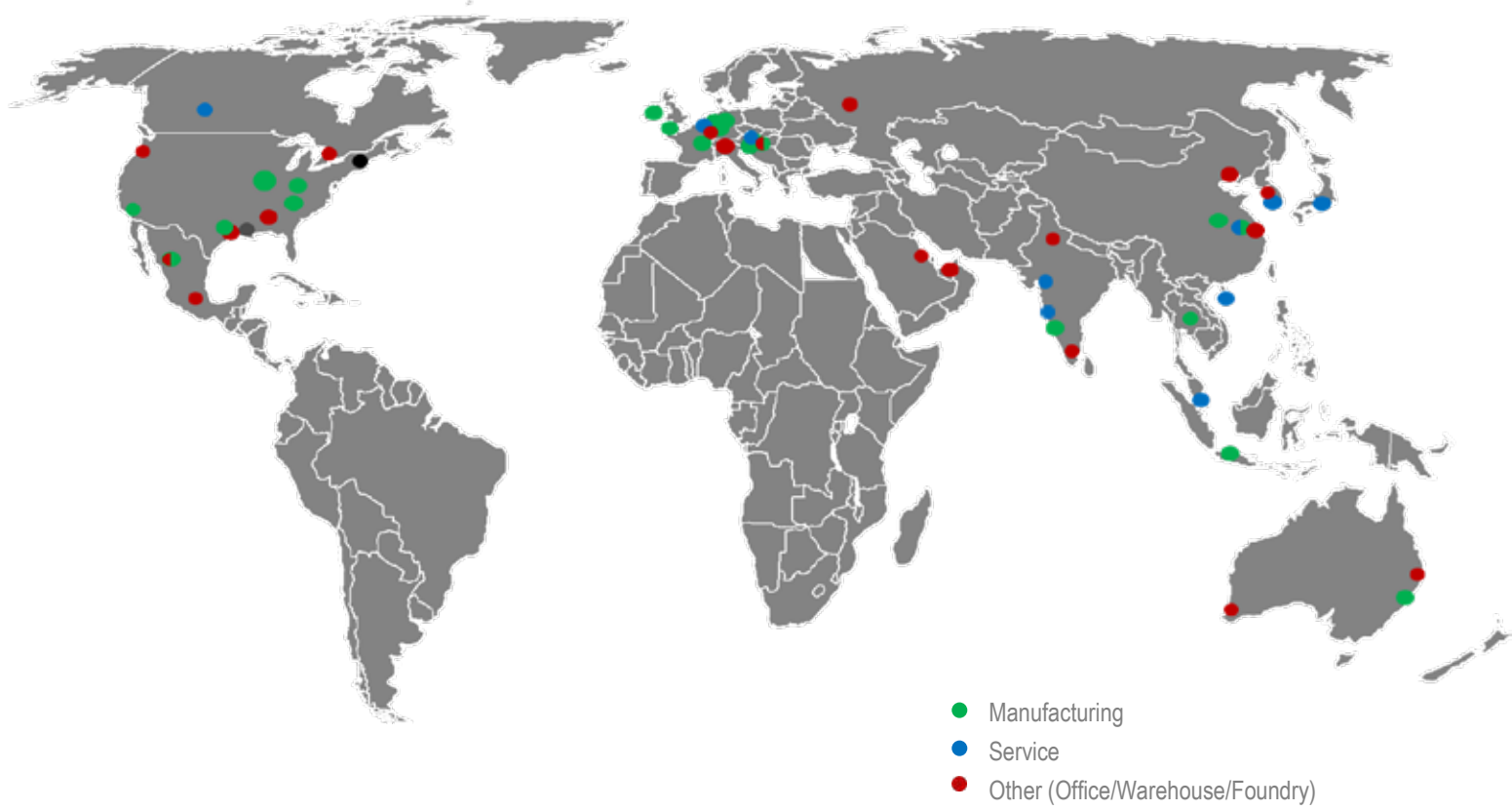

CPE MANUFACTURING SITES (Examples):



Cincinnati, OH Marion, NC Saddle Brook, NJ Muta, SL Lindau, DE Kreuztal, DE Duesseldorf, DE Cwmbran, UK Satara, India Suzhou, China Ningjin, China Singapore



AMERICAS

CHIHUAHUA, MEX • CINCINNATI, OH
• CULLMAN, AL • EDMONTON, AB
GONZALES, LA • HOUSTON, TX •
MARION, NC MEXICO CITY, MEX •
PORTLAND, OR • SADDLE BROOK,
NJ • SPARTANBURG, SC,
HQ: THE WOODLANDS (HOUSTON),
TX



EUROPE

BELFAST, UK • CWMBRAN, UK,
CRONING, SL • DÜSSELDORF, DE
• KREUZTAL, DE • LINDAU, DE •
SZÉKESVERHÉRVÁR, HU MUTA, SL
• MAXDORF, DE • MONZA, IT • MUL-
HOUSE, FR • BERGSCHENHOEK,
NL WAALWIJK, NL • WAVRE, BE •
WR. NEUDORF, AT



ASIA

BEIJING, PRC • CHENNAI (MA-
DRAS), INDIA KANAGAWA, JAPAN •
NINJIN, PRC • PUNE, INDIA SATARA,
INDIA • SHANGHAI, PRC SINGA-
PORE • SUZHOU, PRC • VIRALI-
MALAI, INDIA



AUSTRALIA

BRISBANE • KEWDALE • MEL-
BOURNE • ST. MARYS



MIDDLE EAST

AL KHOBAR, SAUDI ARABIA • DUBAI,
UAE

Process Flow Technologies

VALVE GROUP

BRANDS YOU TRUST

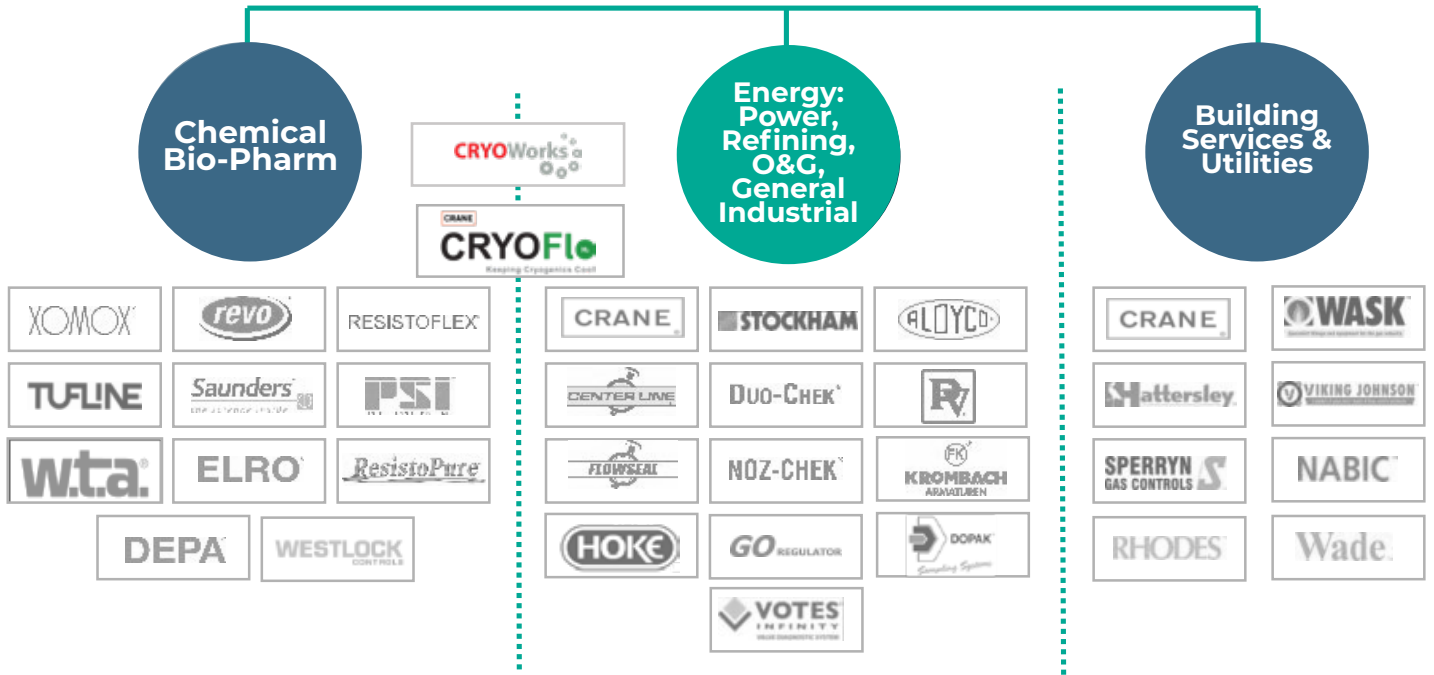



Local **SERVICE**

CRANE is committed to delivering efficient service and local technical expertise.

Crane is built on quality principles and practices to achieve the best safety, quality, performance, delivery, service and total cost.

Our vision as a global provider is to be the Supplier of Choice for on/off process valve solutions in chemical, power and refining, known for best-in-class customer responsiveness.



Quick access to high-demand stock



Engineering support



System design and drawings



MRO services



Training and testing



ABOUT CRANE CRYOFLO®

For hydrogen energy to be an effective and efficient alternative to fossil fuels, liquefaction plants, storage facilities, transportation methods and pipelines must be outfitted with state-of-the-art PVF (Pipe Valves and Fittings) components. Crane® CRYOFLO® will be focused on solving Customer's toughest challenges within the Hydrogen Industry backed by decades of field experience in severe service applications.

Crane® CRYOFLO® Solutions for Hydrogen:

- Production
- Liquefaction
- Transportation
- Transfer
- Storage

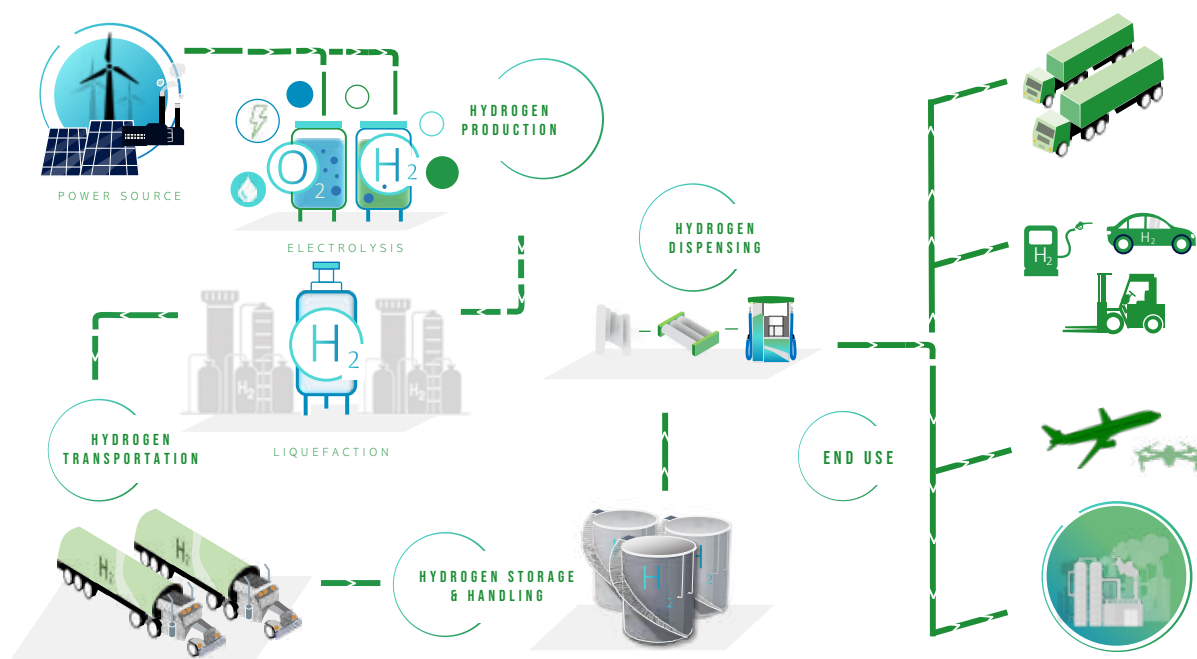

CRYOGENICS VS UNIVERSAL COSMIC COLD

How cryogenic fluids compare to low temperatures across the universe



INTRODUCING BELLOWS SEAL GLOBE VALVE SOLUTIONS

Crane CRYOFLO® offers a distinguished product lineup of vacuum-jacketed valve solutions designed for cryogenic applications, delivering specialized and efficient solutions for the industry.



Bellows Seal T-Globe Valve

Crane® CRYOFLO® has launched a new line of bellows seal globe valves for hydrogen transfer. The valves feature a number of innovative design features that make them ideal for hydrogen transfer applications and are available in a variety of sizes and configurations to meet the needs of different applications. They are also backed by Crane® CRYOFLO®'s comprehensive warranty and support program.

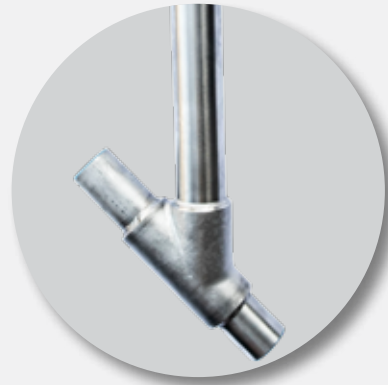

Bellows Seal Y-Globe Valve

Introducing the Crane® CRYOFLO® Bellows Seal Y-Globe Valve: Engineered for superior performance, our Y-pattern globe valve delivers a significantly lower pressure drop compared to traditional vertical globe valves. The innovative non-rotating stem design minimizes friction on moving components, extending the life of the stem packing. Experience effortless operation and reliable tight shutoff, even under extreme pressure conditions, with the Crane® CRYOFLO® Bellows Seal Y-Globe Valve.



Bellows Seal Lift Check Valve

Crane® CRYOFLO® Lift Check Valve is designed to eliminate the risks of system backflow. This valve allows fluid flow in one direction while preventing reverse flow, ensuring unidirectional fluid flow. Ideal for liquid hydrogen applications, the Crane® CRYOFLO® Lift Check Valve offers exceptional reliability and versatility. With its proven durability and resistance to extreme temperatures, it guarantees leak-free operation in even the most demanding environments.



CRYOFLO® Bellows Seal T & Y-Globe Valve

ABOUT OUR VALVE

Crane CRYOFLO® Bellows Seal Globe Valves minimizes Hydrogen loss by improving heat transfer rates, reducing pipeline latency in liquid transfer applications and leveraging a robust zero-leak design.

Improved Flow Rate & REDUCED HEAT

Thermal performance and the Flow Coefficient are two of the most critical aspects to consider when designing high-efficiency cryogenic valves. Utilizing CFD simulations & analysis integral to the design and development of new products, Crane CRYOFLO® is pushing boundaries in Hydrogen.



Reduced Heat Leak

Enhanced engineered design offers best-in-class heat transfer, greatly reducing Hydrogen loss.



Improved CV

Innovative valve internals deliver improved CV in your application, improving liquid transfer times.



In-Line Repair

Unique cartridge replacement system allows for in-line repair, reducing down-time and increasing productivity

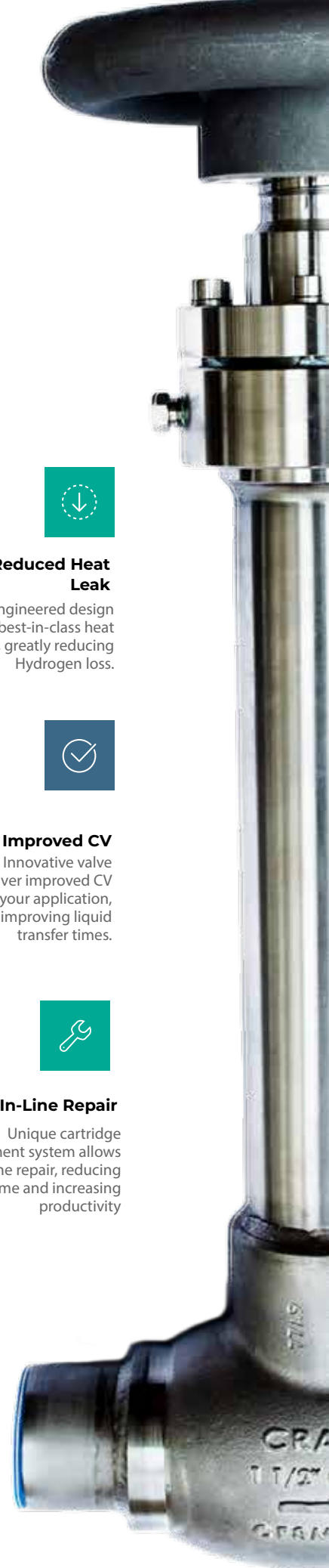
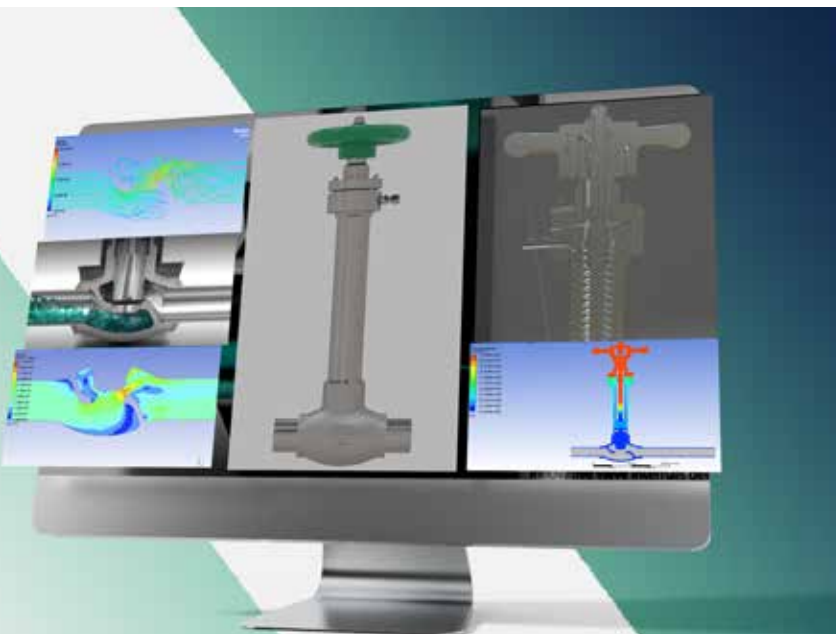



KEY FEATURES

Styles

- T-Globe, Y-Globe

Size Range

- 1/2" - 6"

Pressure Ratings

- 300 psi MAWP

Materials of Construction

- CF8M body, 304ss disc, 316/316L pipe
- CF8M body, 304ss disc, 304/304L pipe
- CF8M body, 316/316L disc & pipe
- CF3M body, 316Lss disc & pipe
- Other materials available upon request.

Design Standards and Compliance

- Designed and Tested to MSS-SP-134
- Designed ISO-28921
- Korean Gas Safety (KGS) Approval
- Canadian Registration (CRN)
- ISO 15848 Fugitive Emissions
- Oxygen clean option per CGA G-4.1
- Fire Safe Design

Temperature Range

Designed for -253°C – 100°C (-423.4°F – 212°F)

End Connections

- Pipe Sch. 10
- Pipe Sch. 5
- Socket Weld , Pipe
- Socket Weld , Tube
- Butt Weld Schedule 40

Assembly Configurations

- Vacuum Jacketed and Non-Jacketed
- Extended bonnet/stem per MSS-SP-134

Sealing and Packaging

- Bellows design to eliminate stem/packing fugitive emissions
- Bellows tested to 10,000 cycles
- Self-Centering PCTFE Seat
- ANSI Class VI Leak Rate

KEY FEATURES

Standard Features

- Proprietary PTFE insert design to limit bonnet dead volume
- Metal-to-metal secondary seat seal
- Spiral wound bonnet flange gasket for improved sealing

Actuator Mounting

- Easy conversion between handwheel and actuator
- Fits most common actuator solutions

Options

- Oxygen cleaning (Process clean standard for LH2 service) for Oxygen system compatibility
- Cold Box Cuff
- Extended Bonnet & Stem lengths

Added applications

- Liquid Hydrogen
- Liquid Helium
- LIN, LAR, LOX, LNG, L-CO2



Available Configurations

- Vacuum Jacketed and Non-Jacketed
- Extended bonnet/stem per MSS-SP-134
- Custom extended bonnets/stems available
- Cold Box Cuff option

Designed for LH2 and other key industrial gases such as LHe, LIN, LOX, LAR, and LNG. Rated to -253°C (-423.4°F)

END CONNECTIONS

The CRYOFLO® valve standard end connection offers exceptional versatility and reliability. We provide a variety of end connection options, including stub ends, butt weld ends, and socket weld ends to meet diverse project requirements. Clients can specify their preferred connections to ensure a precise and optimal fit for their systems.

STUB ENDS

			DESIGNATION	PIPE DETAILS Non-Jacketed	PIPE DETAILS Jacketed
Non-Jacketed			Pipe Sch. 10	End prepped for B16.25/B31.3/B31.12 butt-weld	End prepped for B16.25/B31.3/B31.12 butt-weld
Jacketed			Pipe Sch. 5	Socket weld	Socket weld

SOCKET WELD

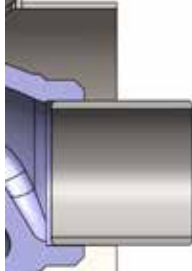
			DESIGNATION	PIPE DETAILS Non-Jacketed	PIPE DETAILS Jacketed
Non-Jacketed			Socket Weld, Pipe	Socket weld	End prepped to socket weld into pipe connector
Jacketed			Socket Weld, Tube	Socket weld	End prepped to socket weld into tube connector

BUTT WELD

			DESIGNATION	PIPE DETAILS Non-Jacketed	PIPE DETAILS Jacketed
Non-Jacketed			Butt Weld Schedule 40	None	None

CRANE CRYOFLO

BELLOWS SEAL VALVES



Size Range

- 1/2" - 6"



Pressure Ratings

- 300 psi MAWP



Assembly Configurations

- Vacuum Jacketed and Non-Jacketed
- Extended bonnet/stem per MSS-SP-134
- Custom extended bonnets/stems available
- Cold-box Cuff option



Typical Applications

- Production, transportation, transfer, and storage of Hydrogen and other cryogenics.

Targeting 6-8 week lead times for standard configurations.

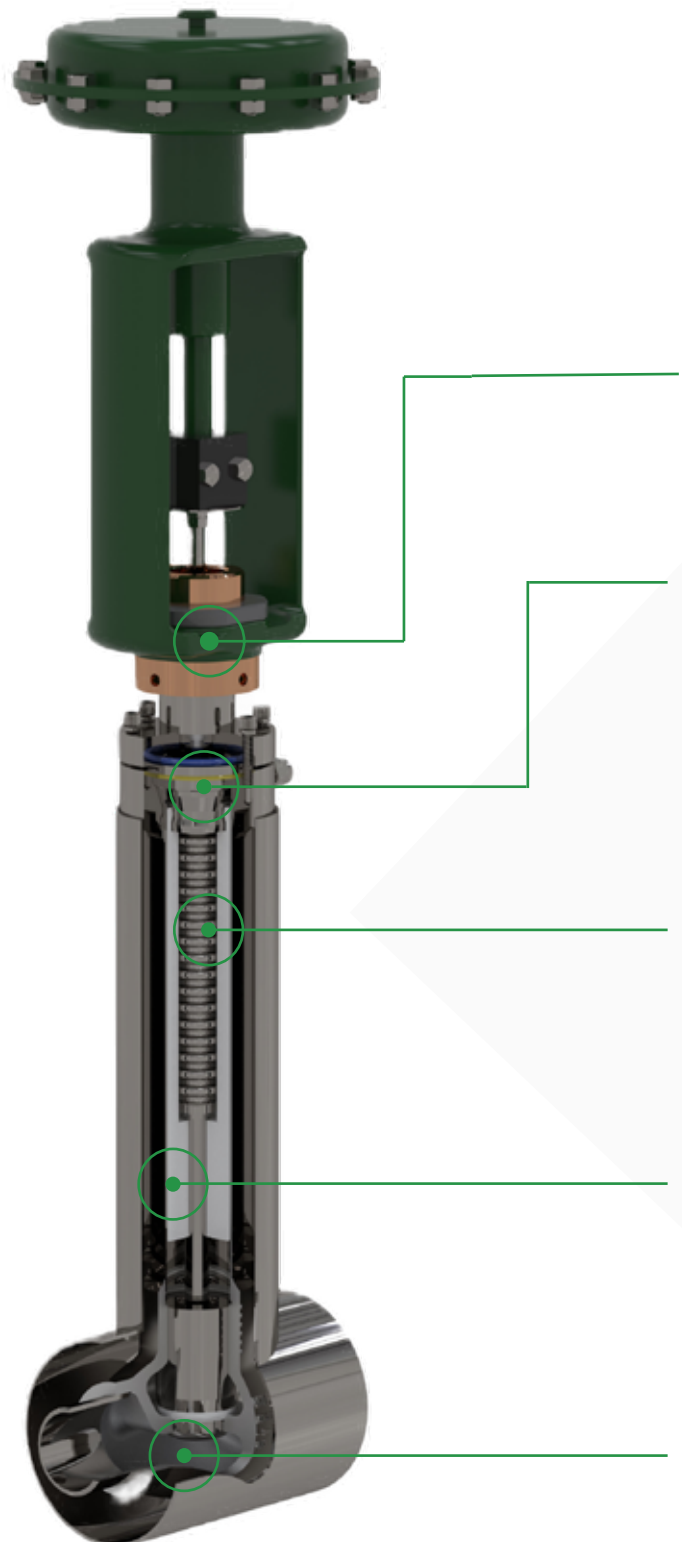

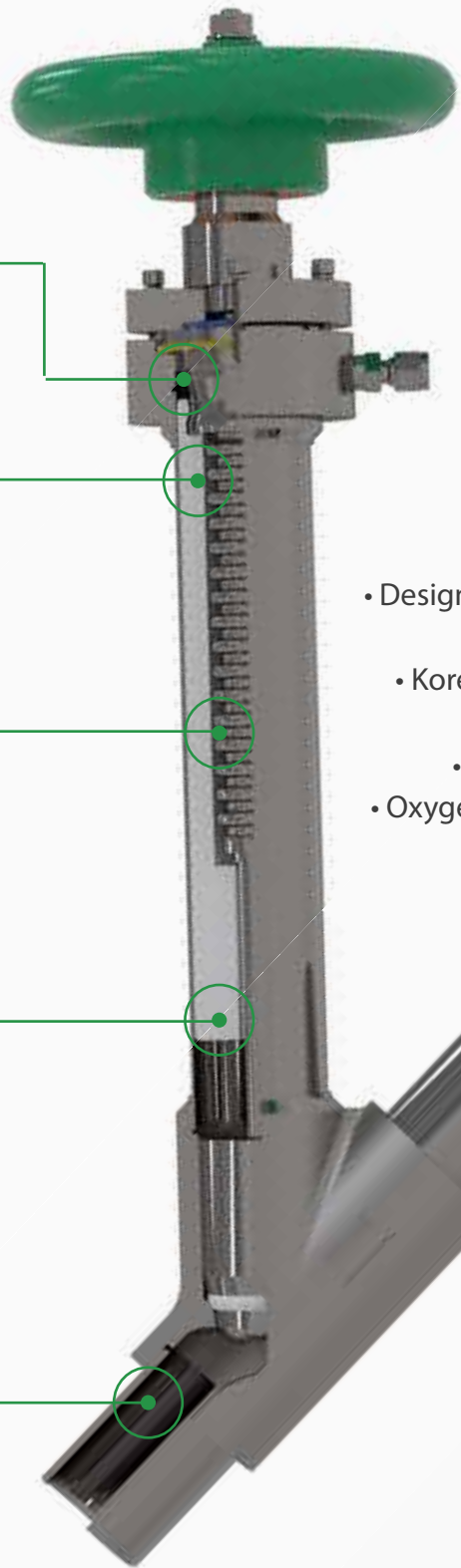

Easily convert from manual hand-wheel to actuation.

Unique cartridge replacement system for efficient in-line maintenance

Proven bellows design for high life cycle

Vacuum barrier and Improved design minimizes heat leak and media boil-off.

Innovative valve internals deliver improved CV while maintaining highest industry bubble-tight shut-off standards.

Operating Option

- Light-Weight Handwheel
- Pneumatic Actuation
- Electric Actuation



Compliance

- Designed and Tested to MSS-SP-134 and ISO-28921
- Korean Gas Safety (KGS) Approval
- Canadian Registration (CRN)
- ISO-15848 Fugitive Emissions
- Oxygen clean option per CGA G-4.1
- Fire Safe Design*



End Connection

- Pipe stub ends
- Butt weld
- Socket weld



IN-LINE REPAIR

The CRYOFLO® valve's unique design utilizes a cartridge replacement system, allowing for efficient in-line maintenance, minimizing operational disruptions, and enhancing productivity. The cartridge replacement system is provided as a complete unit with the seat, disc, and full stem assembly.



TESTING

Research and development, together with practical experience in reconditioning all types of valves, have contributed to the design and manufacture of CRYOFLO® Bellows Seal Globe Valves. High quality materials and workmanship, combined with the modern manufacturing methods used in producing these valves are your assurance of a dependable, uniform product.

MSS-SP-134 prototype approval tests have been performed on all sizes of the Crane CRYOFLO® Bellows Seal Globe Valve. These tests include operating cycles, measurements at ambient, high and low temperatures, and fugitive emission testing in static and dynamic states. Each valve was dismantled, the components inspected and studied by an independent QA/QC inspector, to validate the robustness and integrity of the parts after testing. The end user can rest assured that each valve will perform optimally throughout its lifetime.

5,000 Cycles in Liquid Hydrogen

- Valve tested to 4,000 cycles in Liquid Nitrogen, passing MSS-SP-134
- No valve sweating in liquid hydrogen
- No seat leakage or emissions to atmosphere detected

Bellows tested to 10,000 cycles in liquid nitrogen

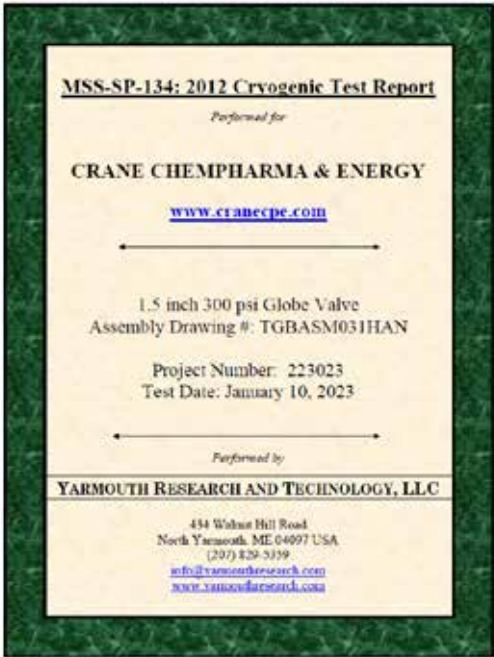

Modified MSS-SP-134 (4000 Cycles)

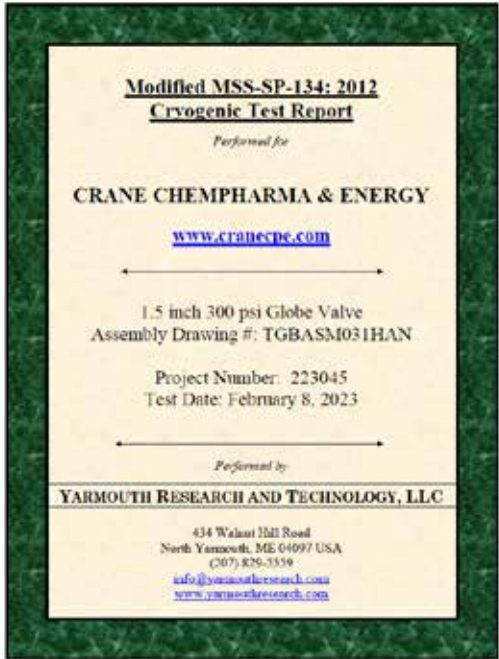

CRANE

CRYOFLO^{H₂}

Keeping Cryogenics Cool





CRYOFLO® Bellows Seal Lift Check Valve

ABOUT OUR VALVE

Crane CRYOFLO® Bellows Seal Lift Check Valves are tailored for hydrogen applications. Engineered with a loose flange bolted bonnet design, these valves accommodate thermal expansion and contraction effectively, ensuring zero leakage and bolstering safety in hydrogen environments.

Our lift check valves are equipped with a precision cone seat design, guaranteeing absolute shut-off to maximize both safety and operational performance.

Improved Flow Rate & REDUCED HEAT

Thermal performance and the Flow Coefficient are two of the most critical aspects to consider when designing high-efficiency cryogenic valves. Utilizing CFD simulations & analysis integral to the design and development of new products, Crane CRYOFLO® is pushing boundaries in Hydrogen.



Reduced Heat Leak

Enhanced engineered design offers best-in-class heat transfer, greatly reducing Hydrogen loss.



Improved CV

Innovative valve internals deliver improved CV in your application, improving liquid transfer times.



In-Line Repair

Unique cartridge replacement system allows for in-line repair, reducing down-time and increasing productivity

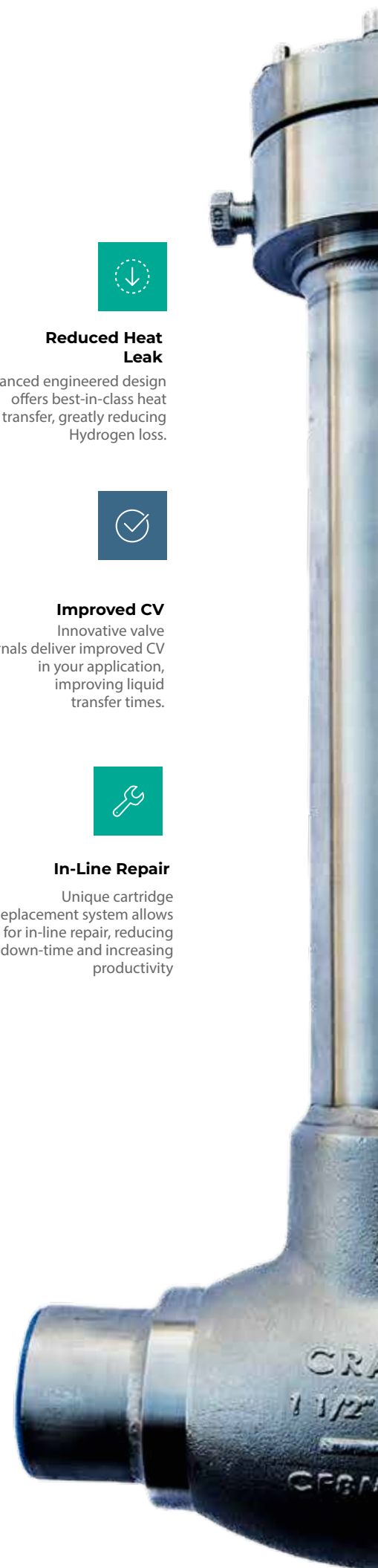

KEY FEATURES

Styles

- Lift-Check

Size Range

- 1/2" - 6"

Pressure Ratings

- 300 psi MAWP

Materials of Construction

- CF8M body, 304ss disc, 316/316L pipe
- CF8M body, 304ss disc, 304/304L pipe
- CF8M body, 316/316L disc & pipe
- CF3M body, 316Lss disc & pipe
- Other materials available upon request.

Design Standards and Compliance

- Bubble Tight at MAWP
- Korean Gas Safety (KGS) Approval
- Canadian Registration (CRN)
- ISO 15848 Fugitive Emissions
- Oxygen clean option per CGA G-4.1

Temperature Range

Designed for -253°C – 100°C (-423.4°F – 212°F)

End Connections

- Pipe Sch. 10
- Pipe Sch. 5
- Socket Weld , Pipe
- Socket Weld , Tube
- Butt Weld Schedule 40

Assembly Configurations

- Vacuum Jacketed and Non-Jacketed
- Extended bonnet/stem per MSS-SP-134

Sealing and Packaging

- Self-Centering PCTFE Seat



KEY FEATURES

Standard Features

- Proprietary PTFE insert design to limit bonnet dead volume
- Metal-to-metal secondary seat seal
- Spiral wound bonnet flange gasket for improved sealing

Options

- Oxygen cleaning (Process clean standard for LH2 service) for Oxygen system compatibility
- Cold Box Cuff
- Extended Bonnet & Stem lengths

Added applications

- Liquid Hydrogen
- Liquid Helium
- LIN, LAR, LOX, LNG, L-CO2



Available Configurations

- Vacuum Jacketed and Non-Jacketed
- Custom extended bonnets/stems available
- Cold Box Cuff option

Designed for LH2 and other key industrial gases such as LHe, LIN, LOX, LAR, and LNG. Rated to -253°C (-423.4°F)

PRODUCT APPLICATIONS

Bellows seal globe valves are an essential component of liquid hydrogen storage tanks and trailers, particularly in applications where safety is of utmost importance. The use of bellows technology prevents the escape of hazardous gases and liquids, making them ideal for use in environments where leaks can have catastrophic consequences.

Bellows seal globe valves are used extensively on liquid hydrogen storage tanks and trailers to load, unload and balance lines. The CRYOFLO® BSGV are design to optimize the flow rate and minimize the pressure loss in liquid transfer applications while maintaining tight shut-off capability and eliminating leaks to the environment.

Applications Include:

- Liquefaction – Cold Box
- Liquid hydrogen storage tanks and transportation
- Storage facilities and pipelines



Bellows seal globe valves are frequently utilized on liquefaction applications. During the liquefaction process, hydrogen gas is cooled to extremely low temperatures, requiring valves that can operate reliably below -253°C (-423.4°F). The CRYOFLO® BSGV has been optimized and tested extensively in liquid hydrogen to maximize flow rates while minimizing heat transfer in these critical applications.

CRANE

CRYOFLO[®]

Keeping Cryogenics Cool



UNIT CONVERSION DATA FOR HYDROGEN

	WEIGHT		GAS		LIQUID	
	pounds (lbs)	kilograms (kg)	cubic feet (scf)	cu meters (Nm ³)	gallons (gal)	liters (l)
1 pound	1.0	.4536	192	5.047	1.6928	6.408
1 kilogram	2.205	1.0	423.3	11.126	3.377	14.128
1 scf gas	.00521	.00236	1.0	.02628	.00882	0.03339
1 Nm ³ gas	.19815	.08988	38.04	1.0	.3355	1.2699
1 gallon liquid	.5906	.2697	113.4	2.981	1.0	3.785
1 liter liquid	.15604	.07078	29.99	.7881	.2642	1.0

	HYDROGEN	NATURAL GAS	GASOLINE	NO. 2 DIESEL
Physical State	Compressed gas or liquid	Compressed gas	Liquid	Liquid
Flammability Range in Air	4.1%-74%	5.3%-15%	1.4%-7.6%	1.0%-6.0%
Lower heating value (btu/lb)	52,217	20,263	18,676	18,394
Boiling Point (°F)	-423	-259	80-437	356-644
Specific Gravity (60°F)	0.07	0.424	0.72- 0.78	0.85
Energy Content per Gallon	gas: 6,500 Btu at 3,000 psi	gas: 33,000 - 38,000 Btu at 3,000 psi	109,000 - 125,000 Btu	128,000-130,000 Btu
Autoignition Temperature (°F)	1,085	900-1170	495	600
Latent Heat of Vaporization	192.1	219	150	100
Freezing Point (°F)	-435	-296	-40	-30 to -40

NOTES

Area for handwritten notes, consisting of alternating light green and white horizontal bands.



CRANE
CRYOFlo
Keeping Cryogenics Cool

INNOVATION DRIVEN BY YOUR NEEDS

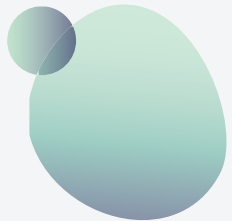

Our businesses are known for proprietary and differentiated technology, quality and reliability, deep vertical expertise, and responsiveness to unique customer needs.

brands you trust.



Corporate Office:

CRANE CHEMPHARMA & ENERGY
4526 Research Forest Drive,
Suite 400, The Woodlands, TX 77381
USA
Tel.: +1-936-271-6500

CRANE ChemPharma & Energy